

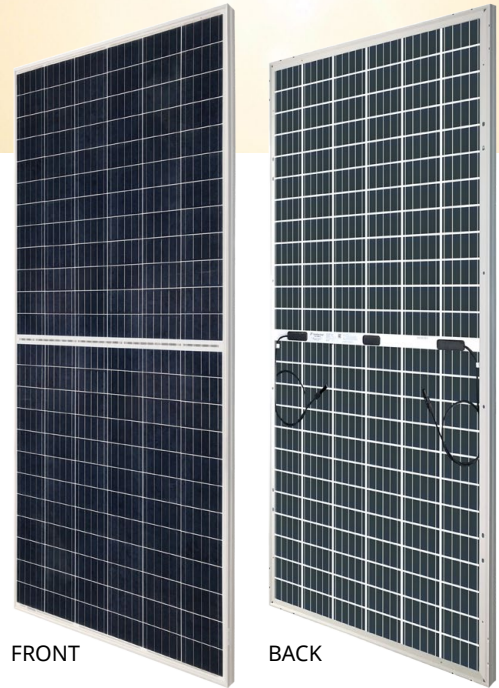





# BiKu MODULE

**NEW GENERATION BIFACIAL MODULE**  
**FRONT POWER RANGE: 350W ~ 365W**  
**ADDITIONAL BACK POWER OUTPUT UP TO 30%**  
**CS3U-350 | 355 | 360 | 365PB-AG**







\* Both 5BB and MBB modules will be supplied.

## MORE POWER

-  Up to 30% more energy yield due to back side power generation
-  Low NMOT: 42 ± 3 °C  
Low temperature coefficient (Pmax): -0.37 % / °C
-  Innovative module design, Better shading tolerance

## MORE RELIABLE

-  Lower internal current, lower hot spot temperature
-  Minimizes micro-cracks and prevents snail trails
-  Fire Class A and Type 3 / Type 13
-  Heavy snow load up to 8100 Pa, wind load up to 4000 Pa \*

 **30 years** power output warranty

 **10 years** product warranty on materials and workmanship

### MANAGEMENT SYSTEM CERTIFICATES\*

ISO 9001:2008 / Quality management system  
ISO 14001:2004 / Standards for environmental management system  
OHSAS 18001:2007 / International standards for occupational health & safety

### PRODUCT CERTIFICATES\*

IEC 61215 / IEC 61730: VDE / CE  
UL 1703: CSA



\* If you need specific product certificates, and if module installations are to deviate from our guidance specified in our installation manual, please contact your local Canadian Solar sales and technical representatives.

**CANADIAN SOLAR INC.** is committed to providing high quality solar products, solar system solutions and services to customers around the world. As a leading PV project developer and manufacturer of solar modules with about 30 GW deployed around the world since 2001, Canadian Solar Inc. is one of the most bankable solar companies worldwide.

\* For detailed information, please refer to Installation Manual.

### CANADIAN SOLAR INC.

545 Speedvale Avenue West, Guelph, Ontario N1K 1E6, Canada, [www.canadiansolar.com](http://www.canadiansolar.com), [support@canadiansolar.com](mailto:support@canadiansolar.com)

## ENGINEERING DRAWING (mm)

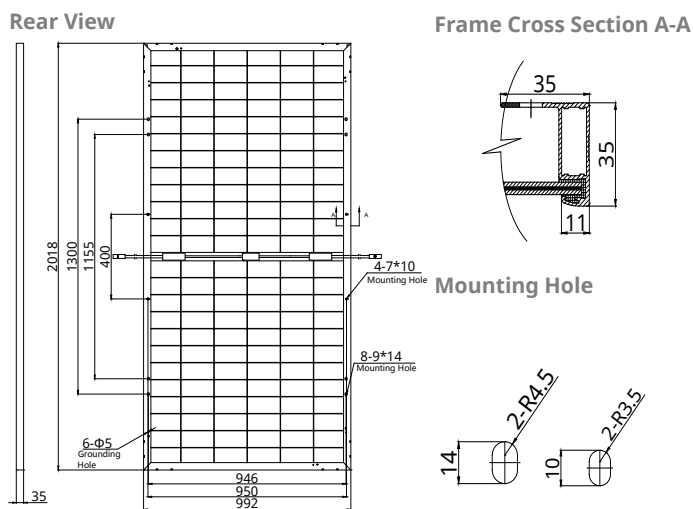

## CS3U-355PB-AG / I-V CURVES

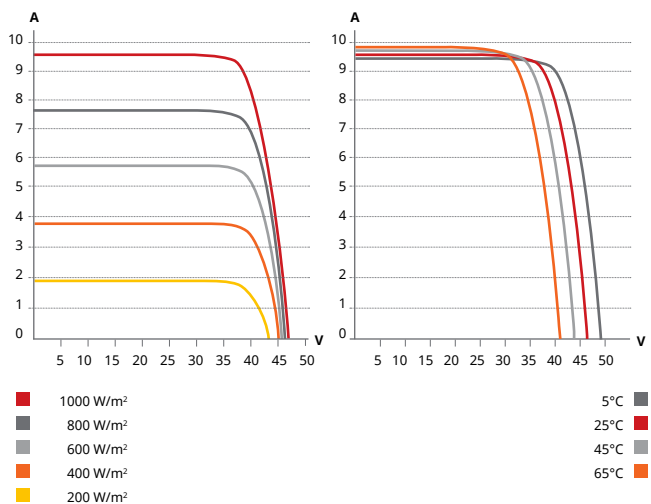

### ELECTRICAL DATA | STC\*

	Nominal Max. Power (Pmax)	Opt. Operating Voltage (Vmp)	Opt. Operating Current (Imp)	Open Circuit Voltage (Voc)	Short Circuit Current (Isc)	Module Efficiency
<b>CS3U-350PB-AG</b>	350 W	39.2 V	8.94 A	46.6 V	9.51 A	17.48%
	5% 368 W	39.2 V	9.39 A	46.6 V	9.99 A	18.38%
<b>Bifacial Gain**</b>	10% 385 W	39.2 V	9.83 A	46.6 V	10.46 A	19.23%
	20% 420 W	39.2 V	10.73 A	46.6 V	11.41 A	20.98%
	30% 455 W	39.2 V	11.62 A	46.6 V	12.36 A	22.73%
<b>CS3U-355PB-AG</b>	355 W	39.4 V	9.02 A	46.8 V	9.59 A	17.73%
	5% 373 W	39.4 V	9.47 A	46.8 V	10.07 A	18.63%
<b>Bifacial Gain**</b>	10% 391 W	39.4 V	9.92 A	46.8 V	10.55 A	19.53%
	20% 426 W	39.4 V	10.82 A	46.8 V	11.51 A	21.28%
	30% 462 W	39.4 V	11.73 A	46.8 V	12.47 A	23.08%
<b>CS3U-360PB-AG</b>	360 W	39.6 V	9.1 A	47 V	9.67 A	17.98%
	5% 378 W	39.6 V	9.56 A	47 V	10.15 A	18.88%
<b>Bifacial Gain**</b>	10% 396 W	39.6 V	10.01 A	47 V	10.64 A	19.78%
	20% 432 W	39.6 V	10.92 A	47 V	11.6 A	21.58%
	30% 468 W	39.6 V	11.83 A	47 V	12.57 A	23.38%
<b>CS3U-365PB-AG</b>	365 W	39.8 V	9.18 A	47.2 V	9.75 A	18.23%
	5% 383 W	39.8 V	9.64 A	47.2 V	10.24 A	19.13%
<b>Bifacial Gain**</b>	10% 402 W	39.8 V	10.1 A	47.2 V	10.73 A	20.08%
	20% 438 W	39.8 V	11.02 A	47.2 V	11.7 A	21.88%
	30% 475 W	39.8 V	11.93 A	47.2 V	12.68 A	23.73%

\* Under Standard Test Conditions (STC) of irradiance of 1000 W/m<sup>2</sup>, spectrum AM 1.5 and cell temperature of 25°C.

\*\* Bifacial Gain: The additional gain from the back side compared to the power of the front side at the standard test condition. It depends on mounting (structure, height, tilt angle etc.) and albedo of the ground.

### ELECTRICAL DATA

Operating Temperature	-40°C ~ +85°C
Max. System Voltage	1500 V (IEC) or 1000 V (IEC/UL)
Module Fire Performance	TYPE 3 / Type 13 (UL 1703) or CLASS A (IEC61730)
Max. Series Fuse Rating	20 A
Application Classification	Class A
Power Tolerance	0 ~ + 5 W

\* The specifications and key features contained in this datasheet may deviate slightly from our actual products due to the on-going innovation and product enhancement. Canadian Solar Inc. reserves the right to make necessary adjustment to the information described herein at any time without further notice.

## CANADIAN SOLAR INC.

545 Speedvale Avenue West, Guelph, Ontario N1K 1E6, Canada, [www.canadiansolar.com](http://www.canadiansolar.com), [support@canadiansolar.com](mailto:support@canadiansolar.com)

### ELECTRICAL DATA | NMOT\*

	Nominal Max. Power (Pmax)	Opt. Operating Voltage (Vmp)	Opt. Operating Current (Imp)	Open Circuit Voltage (Voc)	Short Circuit Current (Isc)
<b>CS3U-350PB-AG</b>	260 W	36.2 V	7.18 A	43.7 V	7.67 A
<b>CS3U-355PB-AG</b>	264 W	36.4 V	7.25 A	43.9 V	7.74 A
<b>CS3U-360PB-AG</b>	268 W	36.6 V	7.31 A	44.1 V	7.80 A
<b>CS3U-365PB-AG</b>	271 W	36.8 V	7.38 A	44.3 V	7.87 A

\* Under Nominal Module Operating Temperature (NMOT), irradiance of 800 W/m<sup>2</sup>, spectrum AM 1.5, ambient temperature 20°C, wind speed 1 m/s.

### MECHANICAL DATA

Specification	Data
Cell Type	Poly-crystalline
Cell Arrangement	144 [2 X (12 X 6)]
Dimensions	2018 × 992 × 35 mm (79.4 × 39.1 × 1.38 in)
Weight	26.3 kg (58.0 lbs)
Front / Back Glass	2.0 mm heat strengthened glass
Frame	Anodized aluminium alloy
J-Box	IP68, 3 diodes
Cable	4.0 mm <sup>2</sup> (IEC), 12 AWG (UL)
Cable Length (Including Connector)	Portrait: 400 mm (15.7 in) (+) / 200 mm (7.9 in) (-); landscape: 1250 mm (49.2 in); leap-frog connection: 1670 mm (65.7 in)*
Connector	T4 series
Per Pallet	30 pieces
Per Container (40' HQ)	660 pieces

\* For detailed information, please contact your local Canadian Solar sales and technical representatives.

### TEMPERATURE CHARACTERISTICS

Specification	Data
Temperature Coefficient (Pmax)	-0.37 % / °C
Temperature Coefficient (Voc)	-0.29 % / °C
Temperature Coefficient (Isc)	0.05 % / °C
Nominal Module Operating Temperature	42 ± 3°C

### PARTNER SECTION

